

# Continuous Cord Loop Cellular Shade Installation Instructions

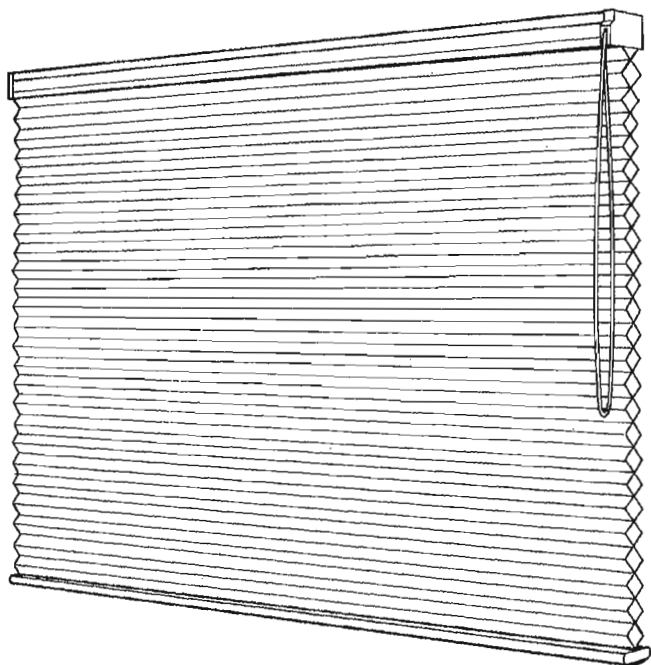

*Ultima*®

Congratulations on the purchase of your new window covering! 3 Day Blinds' products are an attractive choice for your home or office. Included with your purchase is all of the hardware you will need to successfully install your new shade. Please take a moment to read through these instructions before starting.

**3 DAY BLINDS**®

*America's Window Covering Specialists® Since 1978*

1-800-590-SHOP

[www.3day.com](http://www.3day.com)

# Tools & Hardware

## A few simple tools are required:

- Steel tape measure
- Power drill and drill bits (if desired)
- Flathead and Phillips screwdriver
- Pencil
- Level (for outside mount)
- Awl (or tool for starting a screw hole)

Included are the screws needed for a normal installation. Depending on the mounting surface, fasteners other than the screws provided may be required. Wall board and plaster require the use of anchors such as expansion brackets or toggle bolts. Bricks, tile and stone need special plugs and drill bits. Wood should always be pre-drilled to avoid splitting. Professional installation is also available at most 3 Day Blinds locations.

## Standard Hardware

### Mounting Brackets

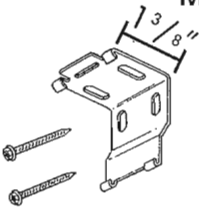

Ultima 3/8" Cellular Shade

- or -

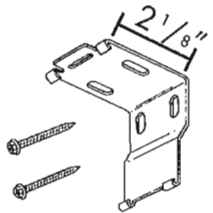

Ultima 3/4" Cellular Shade  
Ultima Dual Cell Shade

### Tension Pulley Bracket

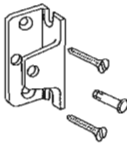

### Hold Down Bracket

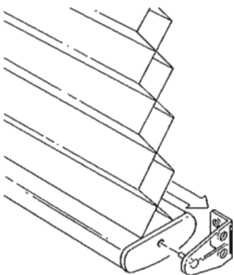

### Extension Bracket with Nuts and Bolts

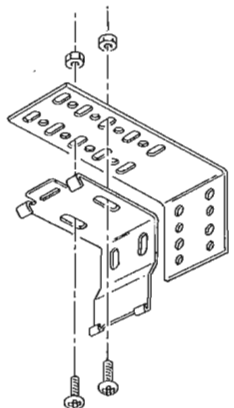

### Spacers



## Bracket Information

Brackets should be installed at each end, 1 1/2" from the ends. Depending upon the width of the shade, additional brackets may be required and will need to be evenly spaced between the two end brackets.

Blind Width		Number of Brackets
10"	31"	2
31 1/8"	- 70"	3
70 1/8"	90"	4
90 1/8"	120"	5
120 1/8"	168"	6

## Inside Mount

- 1 3/8" of flat mounting surface is required to flush mount an Ultima 3/8" Cellular Shade.
- 2 1/8" of flat mounting surface is required to flush mount an Ultima 3/4" or Dual Cell Shade.

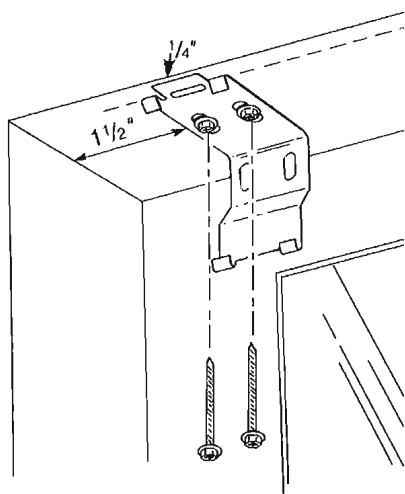

- Brackets should be installed 1 1/2" in from each corner of the window and 1/4" back from the front edge of the window casing. Additional brackets, if required, will need to be evenly spaced between the two end brackets.

- Proceed to "Shade Installation" on Page 4

# Outside Mount

NOTE: You will be using your shade with mounting brackets attached to the headrail to mark the position of the brackets on your wall or molding. DO NOT CUT the cellophane wrapping as the fabric or the cords supporting the shade may be inadvertently cut. Unwrap the cellophane and unwind the shade cord from around the headrail.

- Attach brackets to the headrail 1 1/2" from each end. If additional brackets are required they should be evenly spaced over the width of the headrail. Lower the shade to its full length (See "Shade Operation" on Page 4)

NOTE: If using extension brackets, attach mounting brackets to extension brackets with nuts and bolts before attaching brackets to headrail (See "Optional Accessories" on Page 7.)

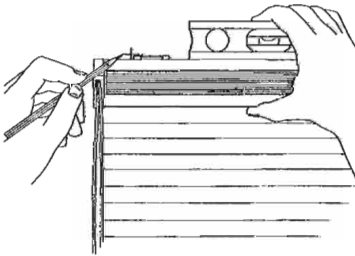

- Hold the shade up to the desired mounting position over the window. Once the shade is level, mark the wall or molding on either side and top edge of each mounting bracket.

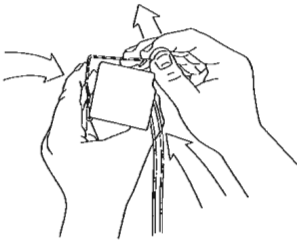

- Remove the mounting brackets from the headrail by pushing back and up on the "tail" of the bracket.

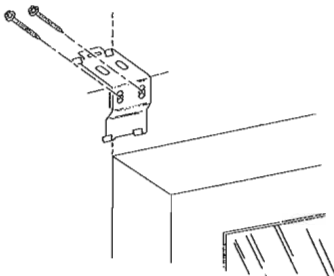

- 1 3/8" of flat mounting surface is required to mount an Ultima 3/8" Cellular Shade.
- 2" of flat mounting surface is required to mount an Ultima 3/4" or Dual Cellular Shade.

## Shade Installation

- If you have not already done so, unwrap the cellophane from around the shade DO NOT CUT the cellophane as the fabric or the cords supporting the shade may be inadvertently cut Also, unwind the shade cord and let it hang down in front of the shade
- With the front of the shade facing you, hold the shade up to the mounting brackets and insert the back lip of the shade into the bottom groove on the bracket

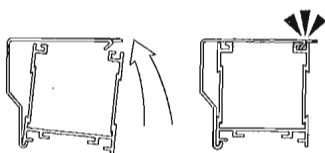

- Rotate the headrail up and back until it snaps into place

## Shade Operation

- To raise the shade, pull on one side of the cord loop
- To lower the shade, pull on the other side of the cord loop After lowering the shade all the way, the shade will begin to raise if you continue to pull the cord in the same direction.

## Child Safety

The Consumer Product Safety Commission requires the use of a cord tie down (cord tensioner) on all continuous loop cord systems. The use of such a device is intended to significantly reduce the occurrence of infant or small child strangulation injuries or death resulting from the looped pull cords on various window treatment products.

The Cord Tensioner is installed on the Lift Cord before packaging.

The Tensioning device should be mounted in the proper position to pull the cord taut in order to reduce the possibility of injury.

## Tension Pulley Installation

### To install:

Mount the tension pulley bracket to the wall or window casing in a position that will keep the cord loop taut and parallel with the shade.

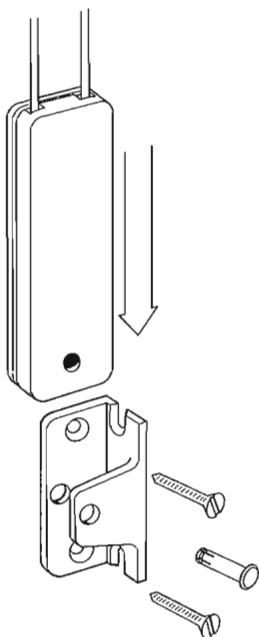

- The cord tensioner can be mounted inside or outside the window frame.
- The control cord must be taut but still operable. Do not allow for any slack. Do not twist or cross the control cord.
- **IMPORTANT:** Do not apply too much tension to the cord or your shade will not operate properly.

# Shade Removal

- Draw the shade completely up (See "Shade Operation" on Page 4.)
- While pinching the headrail and bottom rail together with both hands, gently but firmly rotate the headrail back and forward until the front of the headrail releases from the mounting brackets

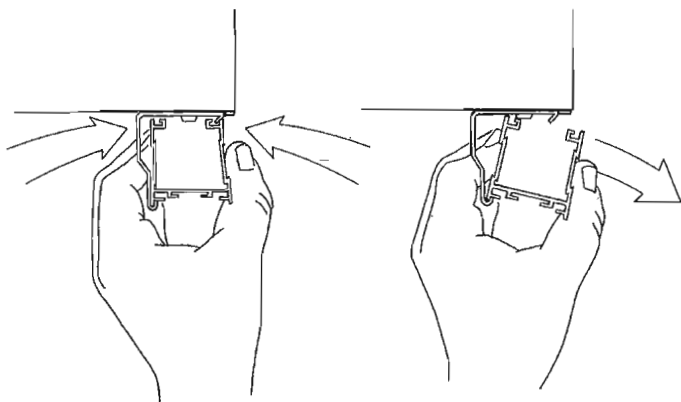

# Optional Accessories

**Extension Brackets** — These are available in two sizes and are used to project the shade up to 3" from the mounting surface. Extension brackets are available at an additional charge and are ideal if your shade must clear an obstruction such as a sliding glass door handle or window crank. Extension brackets require a flat vertical mounting surface of at least 1 3/4".

## To assemble and mount:

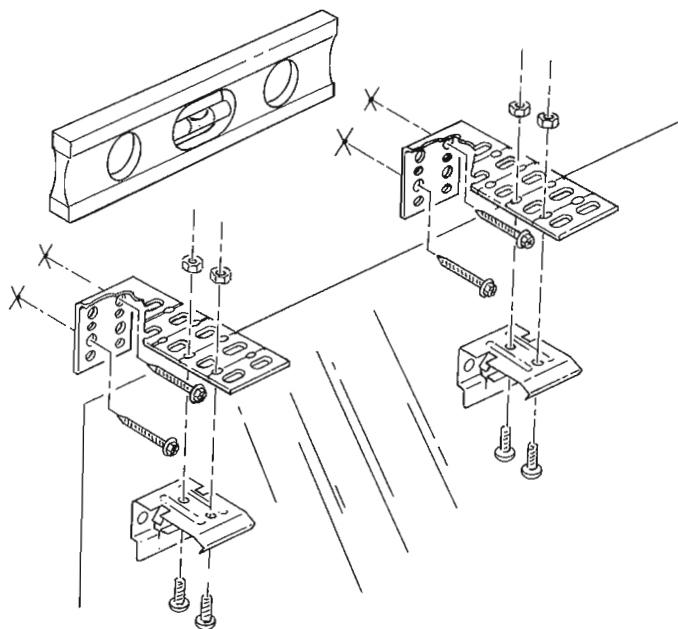

- Attach each mounting bracket to an extension bracket using the nuts, bolts, and washers provided.
- Mount the extension bracket to the wall per the instructions for an "Outside Mount" on Page 3 using a level and making certain that all mounting brackets are level and project the same distance from the mounting surface. For maximum stability, install the screws diagonally from one another.
- Install the shade per the directions for "Shade Installation" on Page 4.

**Spacers** — Available for use on windows with a projected molding. They are 3/8" thick and allow the shade to be mounted flush with the outside edge of any standard window molding. They are free of charge and are available at any 3 Day Blinds showroom.

**Hold Down Brackets** — Used primarily on shades being mounted to doors or in motor homes. They are free of charge and are available at any 3 Day Blinds showroom. There are two small holes in the end caps that are covered by a thin plastic cover. Use the pin on the hold down bracket to punch out the front hole of each bottom rail end cap.

**To install the hold down brackets:**

- With the shade lowered to its full length, place the pin of each hold down bracket into the front hole in each end of the bottom rail.
- Using a pencil, mark the mounting surface through the holes in the hold down bracket. Make sure the hold down brackets are level and aligned with each other.
- Raise the shade and screw the hold down brackets into the mounting surface using the screws provided.

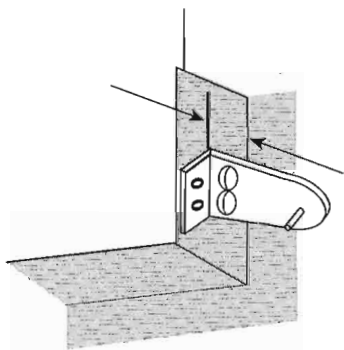

- Mount the hold down to the side or back of the window frame so that the pin lines up with the front hole in the bottom rail end cap with the shade fully lowered.

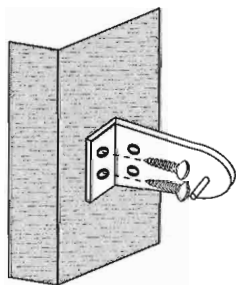

Lower the shade and flex the hold down bracket outward so that the pin can be inserted into the hole in the end cap.

## Care & Cleaning

Frequent dusting or vacuuming with a soft brush attachment will help to ensure a long life for your shade. Soiled fabric can be gently spot cleaned with a mild soap and a soft damp sponge or cloth. Once cleaned, draw the shade up to its maximum open position and allow it to dry. This will help the shade to maintain its pleat retention.

3 Day Blinds also offers products specifically designed to safely and quickly clean fabric shades. Use of strong detergents, spot removers or ammonia based solutions will damage fabric shades and are not recommended.



## WARNING



Young children can strangle in cord and bead chain loops. They can also wrap cords around their necks and strangle.

- Always keep cords and bead chains out of children's reach.
- Move cribs, playpens, and other furniture away from cords and bead chains. Children can climb furniture to get to cords.
- Do not tie cords together. Make sure cords do not twist together and create a loop.

## Limited Lifetime Warranty

3 Day Blinds, Inc., will repair or replace any part of the blind found to be defective in materials or workmanship at no cost to you. This warranty is limited to the original consumer purchaser of the blinds. There is no time limit to our warranty, excluding Essentials®-line products which come with a 1 year limited warranty. This warranty does not apply to any defect caused by improper installation, alteration, abuse, misuse or exposure to excess moisture. This warranty does not cover normal wear and tear such as the natural deterioration of fabric and changes in color that take place over time. This warranty does not cover products that exceed 3 Day Blinds' size recommendations. To obtain service, bring the product(s) in question to any 3 Day Blinds store with this warranty and your purchase invoice. This warranty gives you specific legal rights and you may also have other rights which vary from state to state.

# **3 DAY BLINDS®**

*America's Window Covering Specialists® Since 1978*

1-800-590-SHOP

[www.3day.com](http://www.3day.com)

PART #00001-005/000-024 REV 3-05

© COPYRIGHT SEPTEMBER 2001

3 DAY BLINDS, INC.